

FEATURES - Chicago *LL-0740

- Available in:



- Clear anodized aluminum finish
- The anodized aluminum 6360 T5 is used for better dissipation of heat

- The components are certified
- These products are manufactured in Canada
- In lengths of 8 feet

DIFFUSER - Accessories

The **OPALINE** diffuser allows to pass **55%** of luminosity, **FROST 85%** and **CLEAR 98%**



OPALINE
LL-0740-8-OPA

FROST
LL-0740-8-FROST

CLEAR
LL-0740-8-CLEAR

Material: ACRYLIC DR

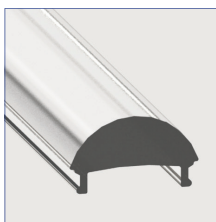
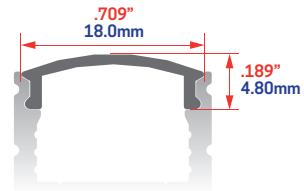

FOCUS
LL-0740-8-FOCUS

Material: ACRYLIC DR

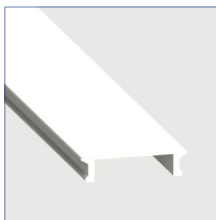
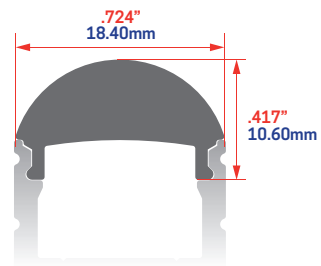

FLAT
LL-0740-8-FLAT

Material: ACRYLIC DR

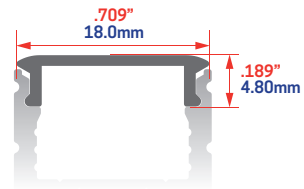

END CAP - Accessories

▪ Available in:



GRAY



BLACK

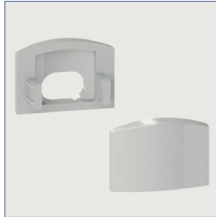

END CAP

LL-0740ECMP (WITHOUT HOLE)
LL-0740ECFP (WITH HOLE)

Material: ABS

Press Fit

▪ Available in:



GRAY



END CAP

LL-0740ECMP-FLAT (WITHOUT HOLE)
LL-0740ECFP-FLAT (WITH HOLE)

Material: ABS

Press Fit



END CAP FOCUS

LL-0740ECMP-FOCUS (WITHOUT HOLE)
LL-0740ECFP-FOCUS (WITH HOLE)

Material: ABS

Press Fit

MOUNTING APPLICATION - Accessories

▪ Available in:



ALUMINUM-AL



BLACK -NR

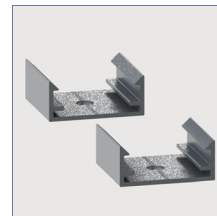

MOUNTING BRACKET

LL-0740BK

Material: ALUMINIUM

MOUNTING APPLICATION - Chicago *LL-0740

CHICAGO - LL-0740-8



CHICAGO - LL-0740-8-FOCUS



CHICAGO - LL-0740-8-FLAT

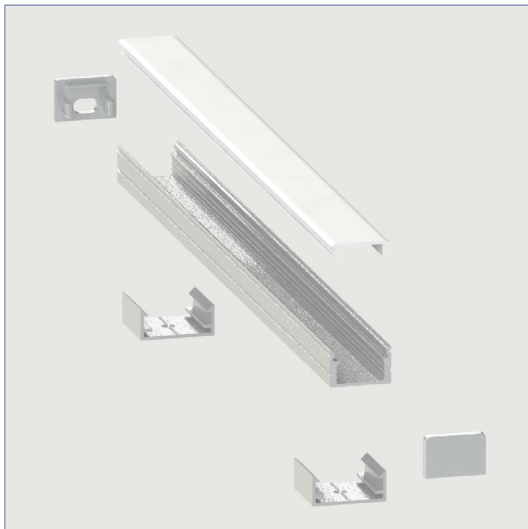

CODES

CHICAGO

EXTRUSION

ALUMINIUM	- LL-0740-8-AL
BLACK	- LL-0740-8-NR

DIFFUSER

OPALINE	- LL-0740-8-OPA
FROST	- LL-0740-8-FROST
CLEAR	- LL-0740-8-CLEAR
FOCUS	- LL-0740-8-FOCUS

FLAT

FROST	- LL-0740-8-FLAT-FROST
--------------	------------------------

END CAP (Press Fit)

STANDARD	- LL-0740ECMP (WITHOUT HOLE) - LL-0740ECFP (WITH HOLE)
FOCUS	- LL-0740ECMP-FOCUS (WITHOUT HOLE) - LL-0740ECFP-FOCUS (WITH HOLE)
FLAT	- LL-0740ECMP-FLAT (WITHOUT HOLE) - LL-0740ECFP-FLAT (WITH HOLE)
BLACK	- LL-0740ECMP-NR (WITHOUT HOLE) - LL-0740ECFP-NR (WITH HOLE)

MOUNTING BRACKET

ALUMINIUM	- LL-0740BK-AL
BLACK	- LL-0740BK-NR